



[www.acrn.fr](http://www.acrn.fr)

# ACRN

Quality Control Machine  
Industry & Packaging

## MULTITEST-DV



**MOTORIZED TRACTION/  
COMPRESSION STAND**

# MULTITEST-DV

## MOTORIZED TRACTION/ COMPRESSION STAND

### FUNCTION

The Mutitest-DV is a versatile and compact motorized test bench, offering excellent value for money. It allows to realize precise tensile / compression tests, in particular thanks to its sophisticated electronic components and its ergonomic control plate.

This single-column bench offers a wide range of functions, especially when it combined with an advanced force sensor. In addition, coupled with high-performance software, it will be easy for you to fully trace and process your acquisition data.

Finally, thanks to the multiple adaptable accessories on the stand, it will be able to fully meet your needs while staying as close as possible to your budget. Its small size and robustness will facilitate testing in the production area and provide quality control in the laboratory.

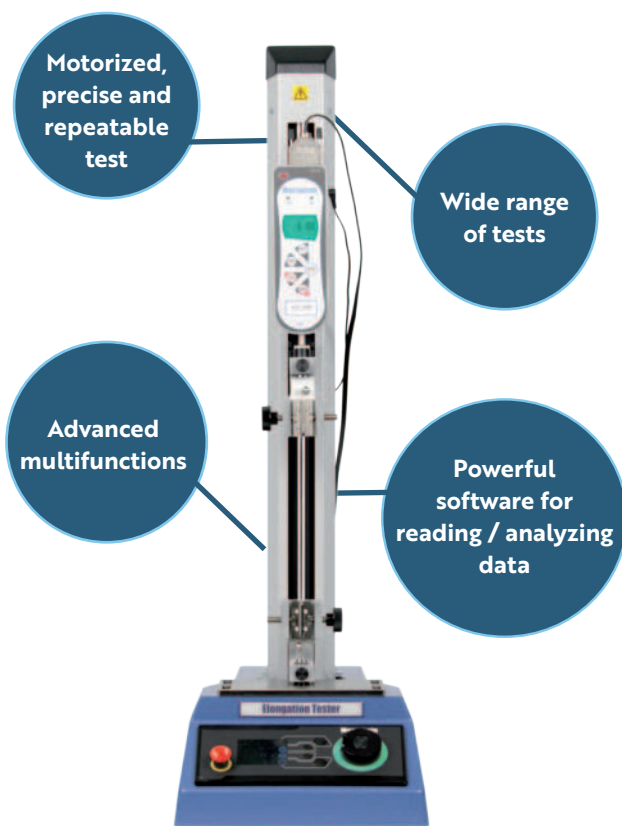

### TECHNICAL INFORMATION

<b>Capacities</b>	0.5 kN	1 kN	2,5 kN
<b>Mountable sensors</b>	Digital force gauge, force sensor		
<b>Test mode</b>	- manual traction / compression - between 2 trips - between 2 limits - between 2 loads		
<b>2 level tests with digital force gauge AFG</b>	<b>Autonomus</b> - Peak value - Displacement limit		<b>Connected to the bench</b> - Load limit - Break limit
<b>Displacement resolution</b>	0.001 mm		
<b>Position precision</b>	+/- 0.130/300 mm		
<b>Velocity range Nb test/ cycle</b>	0.1 to 1200 mm/min 9 999		
<b>Velocity resolution</b>	0.1 mm/min		
<b>Velocity precision</b>	+/- 0.2 % of the indicated velocity		
<b>Power supply</b>	230V AC 50 Hz / 110V AC 60 Hz		
<b>Power</b>	120 W	200 W	250 W
<b>Safety</b>	Lockable thumbwheel		

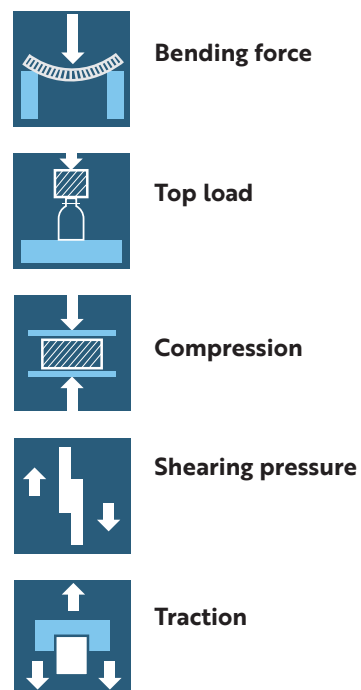

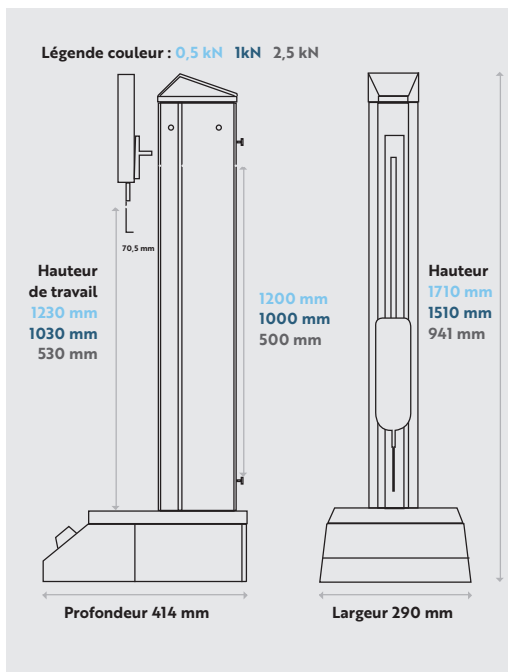

## VECTOR PRO LITE

### ● Program creation

- Test permissions
- Test operation
- Résultats : area calculation, average, adjustment, peak, etc.

### ● Real-time curve

- Instant calculation
- Compliant / non-compliant result
- Revisions results: curve comparison, invert axes, zoom, etc.

### ● Processing results

- Graph comparison
- Parameter adjustment
- Export of raw data or in the form of tables, in Excel or PDF format for test reports.

## OPTIONS

<b>Vector Pro Lite Software</b>	Connection with Stand + AFG or BFG
<b>Vector pro MT Software</b>	Connection with Stand + ELC (material test)

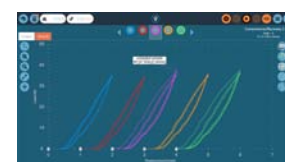

Test Status: 5 cycle (20 mm PE Foam Recovery)

Test Name: Compression (20mm PE)

Sample	Area(Nmm)	First Peak(N)	Last Peak(N)
1.1	120.26	34.00	37.00
1.2	120.40	34.00	36.00
1.3	121.74	37.00	37.00
1.4	120.70	34.00	37.00
1.5	121.08	37.00	37.00
1.6	120.47	34.00	34.00
1.7	120.48	34.00	34.00
1.8	121.28	34.00	34.00

## VARIOUS APPLICATIONS:



● Extraction



● Bending



● Insertion

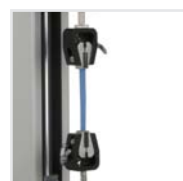

● Traction



● Compression



● Lengthening at the break

**MAIN ACCESSORIES:**



● Rotation Crimp Receptacle



● Wedge Grip traction / tearing

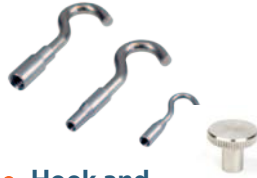

● Hook and compression plate



● Cable Cam Grip Cable traction



● Multijaw Particularyly Cork traction (any material)

---

**ACRN A GLOBAL OFFER**  
*for your packaging quality controls*

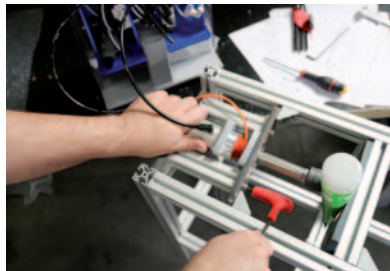

**Calibration and annual maintenance**

ACRN is equipped with a metrology laboratory.

**Setting up tests, choice of materials, state of the art, work on repeatability**

we can advise you according to your needs (technology, budget, ergonomics).

**Leak testing and dynamometric testing**

Our skills and equipments for leak testing and dynamometric testing for packaging

---

**Major manufacturers have trusted us for many years**

